

Introduction of connected monitor



VM-5 Series Monitor

The VM-5 series Monitors are designed in accordance with the API 670 4th Edition for use on rotating machinery. Both 8 or 10-slot rack mount type and one-unit standalone type with a built-in power supply are available so the monitor can be applied for any system design from a few channels of vibration monitoring for small machinery to TSI for large turbines.

High reliability by the use of duplex power supply
Easy monitoring by the perfect display function.
Provided with the self diagnostic function.

VM-7 Series Monitor

The VM-7 series monitor is designed according to the ISO International Standards and the API Standards, and has the functions and features as the Machine Condition Monitor for the critical machines in the plant, and is used for the Machine Protection System defined in the API standard 670 in particular.

4CH Vibration/Displacement Monitor Module & 6-CH Temperature Monitor Module
Up to 40 Vibration channels can be installed in a 19"-Rack
All modules can be installed and removed from front side, and hot replaceable

VM-16 Series Monitor

The VM-16 is a 4, 8 or 12-channel machine condition monitor to measure vibration, axial position and temperature, and the monitoring parameters can be assigned to any channel. The color LCD display indicates all information, and it is also a touch panel that allows to setup configuration.

Trend data memory function : CompactFlash™ Memory card and USB port
Displacement, Velocity, Acceleration, Axial position and Temperature
Hazardous area approvals: CSA (pending)

VM-21 Series Conditioner

The VM-21 series signal conditioners accept the signal from transducers installed on rotating machinery and convert it to a 4 to 20 mADC or 1 to 5 VDC output.

Displacement, velocity, acceleration and LVDT
Small and light-weight
Free choice between DIN rail or wall mounting in any convenient location
Burn-down function at the output side for quick fault detection
Equipped with vibration waveform output for high precision diagnosis

We have the vibration analysis/diagnostics and the remote monitoring systems other than above mentioned monitors. Please contact us for farther information.



Published in Mar.2009

Contact to

SHINKAWA Electric Co., Ltd.

Tokyo Head office
3rd Fl. Shin-kojimachi Bldg.3-3 Kojimachi 4-chome, Chiyoda-ku, Tokyo 102-0083, Japan
Phone : 81-3-3263-4411 Fax : 81-3-3262-2171

International Trade Dept.
Phone : 81-3-3263-4417 Fax : 81-3-3262-2171
WEB : <http://www.shinkawa.co.jp/>

Hiroshima Head office
10-9, Mikawa-cho, Naka-ku, Hiroshima-shi, Hiroshima, 739-0029, Japan
Phone : 81-82-247-4211 Fax : 81-82-249-6438
WEB : <http://www.shinkawa.co.jp/>

SHINKAWA Sensor Technology, Inc.

4-22 Yoshikawa-kogyodanchi, Higashihiroshima 739-0153, Japan
Phone : 81-82-429-1118 Fax : 81-82-429-0804
WEB : <http://www.sst-shinkawa.co.jp>

* Specifications, outline drawings and other written information can be changed without notice.

United States : SEC of America Inc.

6934 Beach drive SW, Ste.4, Ocean Isle Beach
NC 28469-5797, USA
TEL.1-910-579-3220 FAX.1-910-575-3238
URL : <http://www.sec-america.com/> E-Mail info@sec-america.com

China : SHINKAWA Electric of Shanghai Co., Ltd.

16G, NO 379 Pudong South Road, Pudong New District,
Shanghai 200120, China
TEL.86-21-6886-9482 FAX.86-21-6886-9404
URL : <http://www.shinkawa.com.cn/>

Singapore :

SHINKAWA Electric Asia Pte. Ltd.

15 Queen Street, #03-08, Tan Chong Tower
Singapore 188537
TEL.65-6339-2393 FAX.65-6334-5510

FK-202F

Non-contact Displacement / Vibration TRANSDUCER

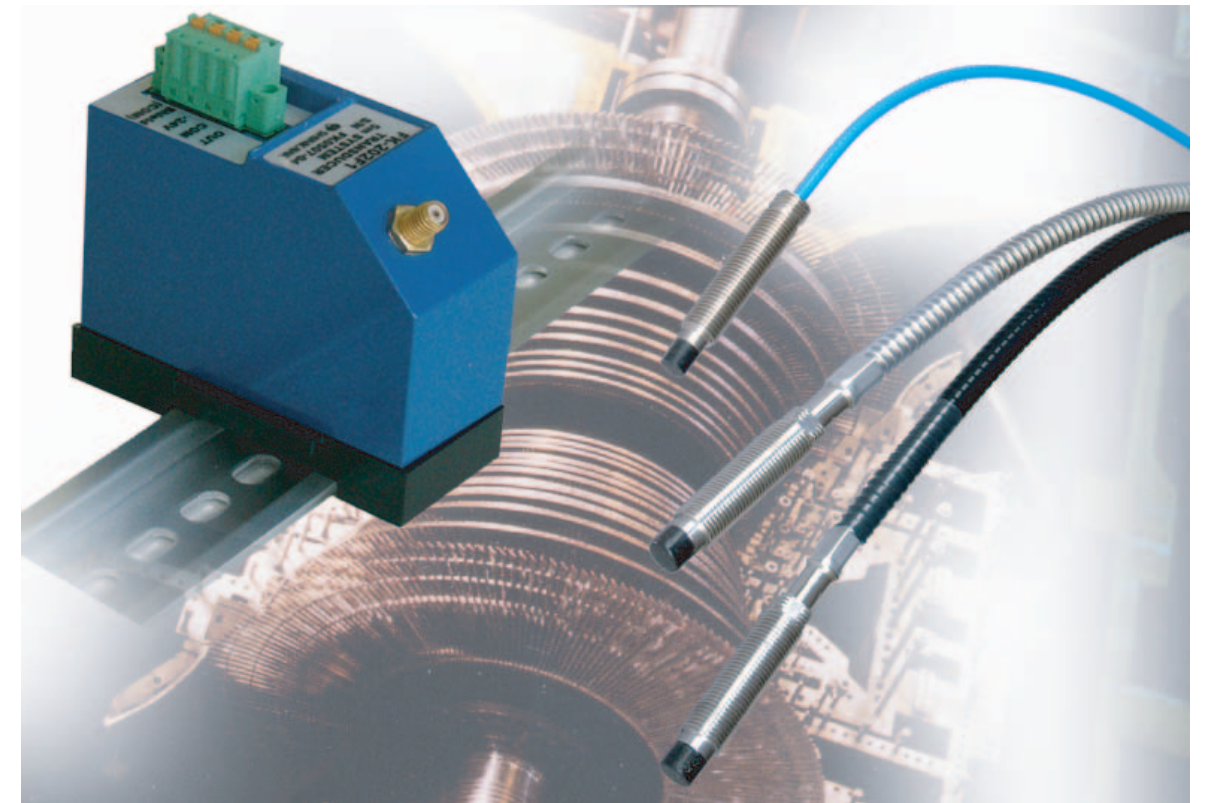

- Suitable for various applications: Shaft Vibration, Axial Position, Rotating Speed and Phase Mark of the critical rotating machinery.
- Environmental friendly design: Lead-free soldering, RoHS Directive Compliant and Downsized.
- Wide variety of Driver mounting: DIN-rail adaptor, 4-screw-cramp plate adaptor (to replace VK series and others)
- API standard 670 (4th Edition) Compliant
- Intrinsically Safe: TIIS, CSA, ATEX, NEPSI, KTL
- CE Directive Compliant

FK-202F Non-contact Displacement/Vibration Transducer

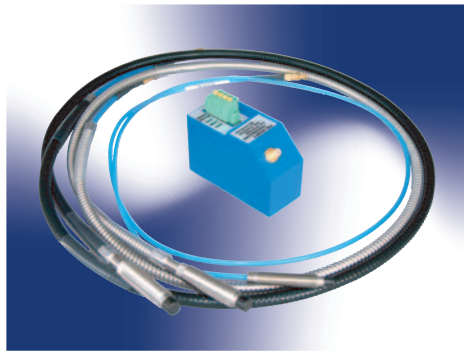

The FK-202F transducer is the eddy current type non-contact displacement/vibration transducer, used for measuring Shaft Vibration, Axial Position, Rotating Speed and Phase Mark (Phase Reference) from small rotating machinery to large critical machinery such as turbines and compressors in plants.

Designed with due considerations for environments, the FK-202F has achieved lead-free soldering, RoHS Directive¹ compliance, also downsizing the driver².

In addition, the FK-202F is designed to meet the API (American Petroleum Institute) standard 670 (4th Edition) requirements, often referred by the Machinery Protection Systems for the petroleum refinery and the petrochemical plant in world wide.

¹ RoHS (Restriction of the use of certain Hazardous Substances in electrical and electronic equipment) directive defines six restricted substances: lead, mercury, cadmium, hexavalent chromium, polybrominated biphenyls and polybrominated diphenyl ethers.

² The FK driver is downsized to approximately two-thirds of existing model of the VK series.

FK System Configuration

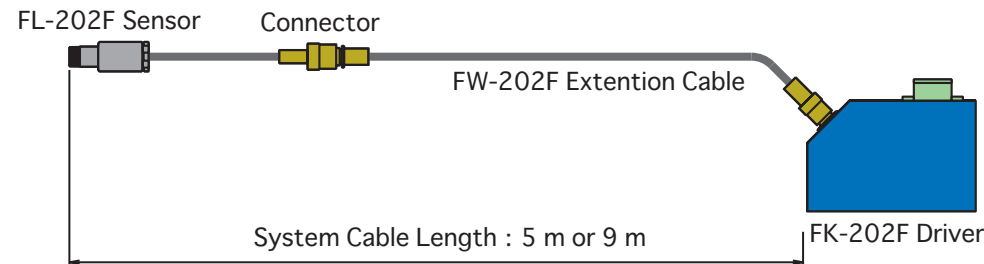

Example of Application

Typical system arrangement for a turbine (Quotation from API 670 (4th Edition) APPENDIX H)

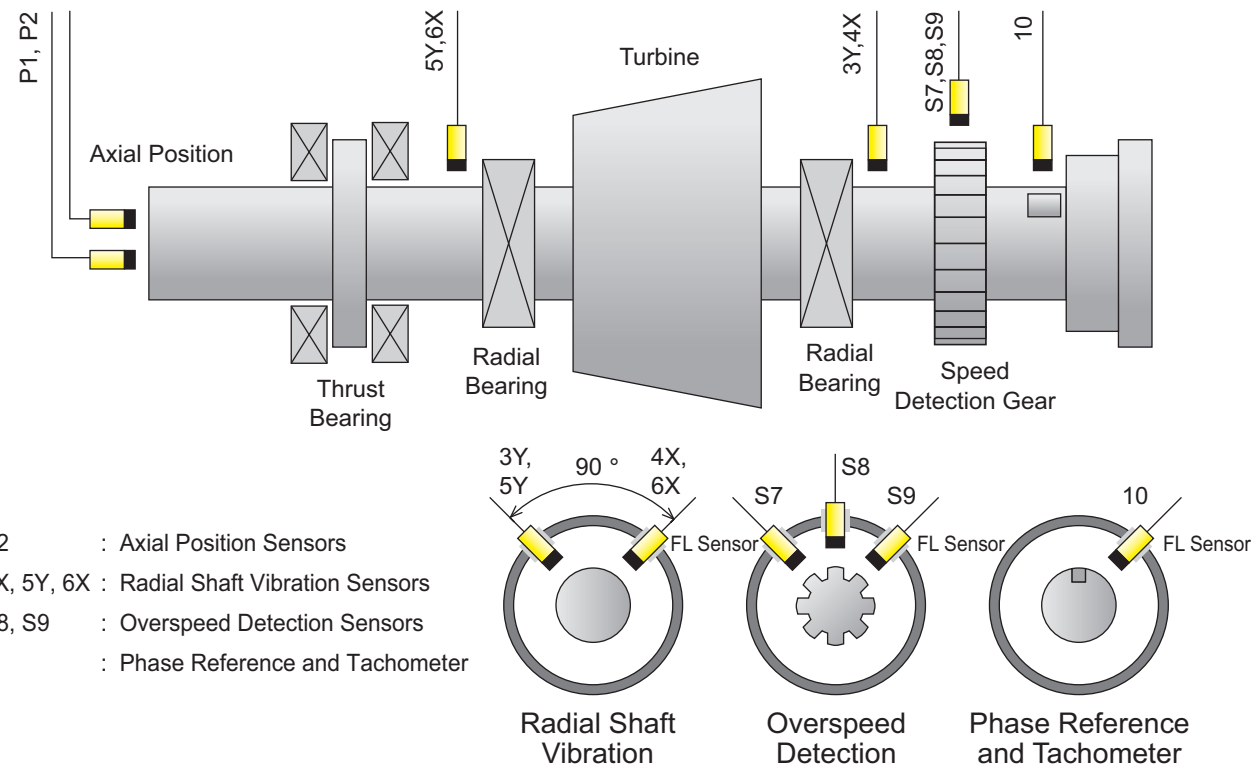

- P1, P2 : Axial Position Sensors
- 3Y, 4X, 5Y, 6X : Radial Shaft Vibration Sensors
- S7, S8, S9 : Overspeed Detection Sensors
- 10 : Phase Reference and Tachometer

Characteristics Data

Standard Static Characteristics
Target Material : SCM440 Flat Face
(dia. 15 mm or more)

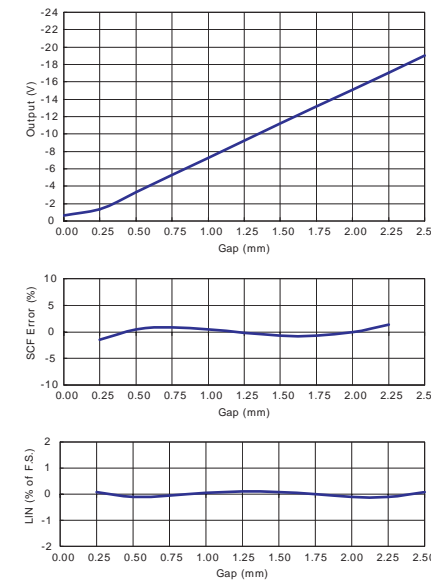

Target Material Effect

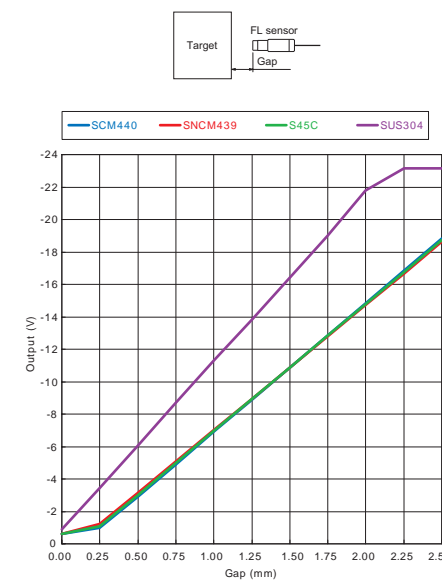

Target Diameter Effect

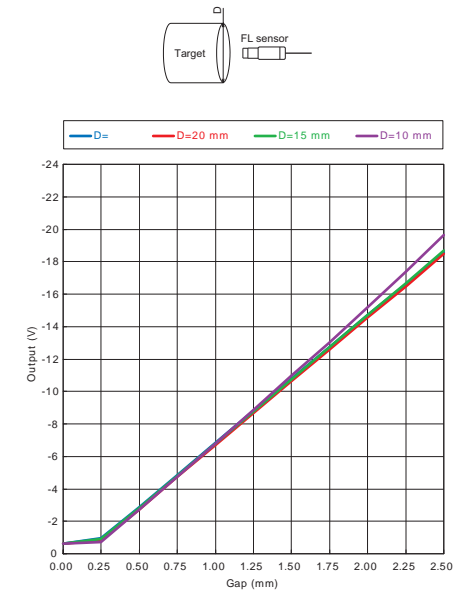

Curved Surface Target Effect

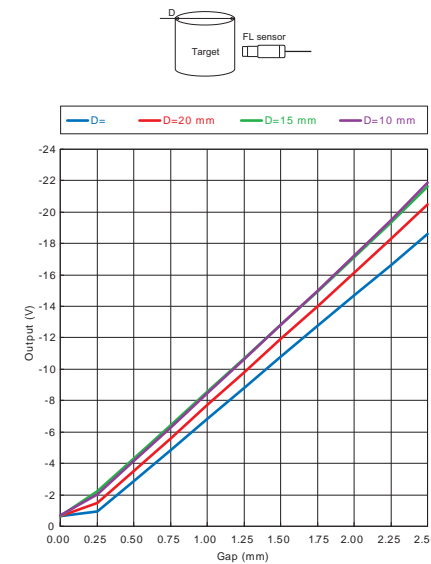

Target Edge Effect

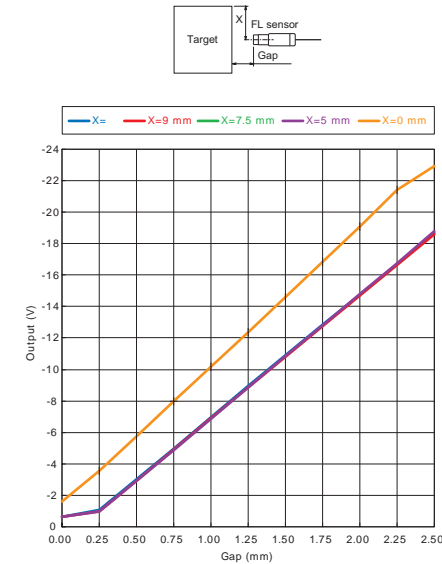

Side Wall Effect

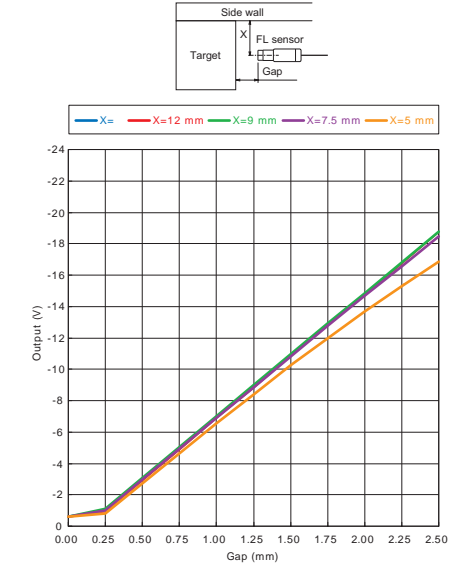

Frequency Response

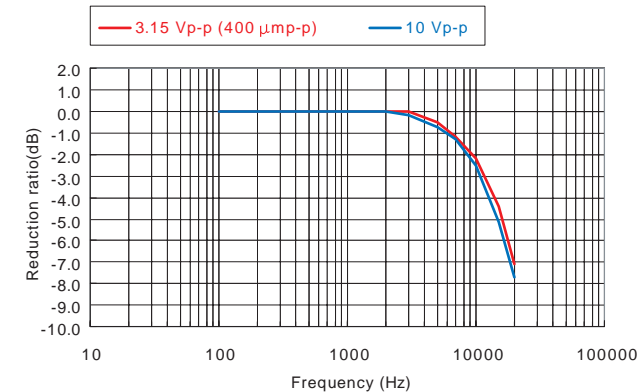

FK Driver Model Code Number and Outline Drawing

Model Code Number

FK-202F□-□

System Cable Length		Mounting Plate	
1	5 m	1	3DIN Rail (35 mm) Mount
2	9 m	2	Screw Mount (50.8 × 50.8 mm)
		3	Screw Mount (92 × 31 mm : For VK Replacement)
		4	Screw Mount Multi-pitch (50.8 × 50.8 mm and 92 × 31 mm)

FK-202F -1(DIN Rail Mount)

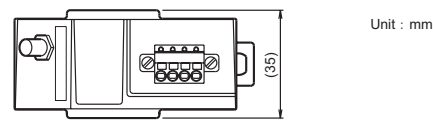

FK-202F -3(Screw Mount : For VK replacement)

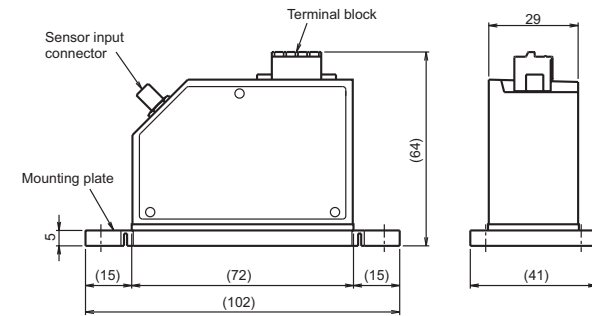
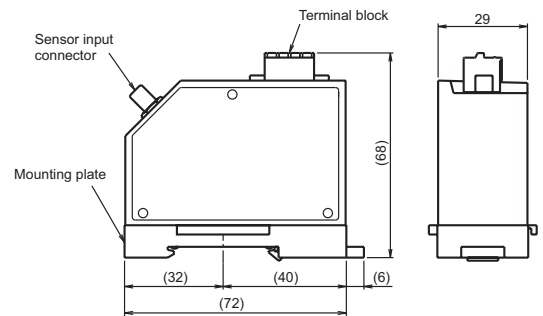
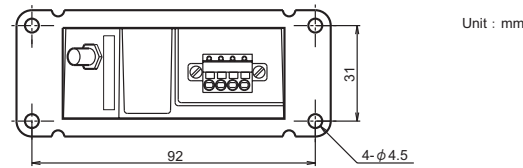

FK-202F -2(Screw Mount : 50.8 × 50.8mm)

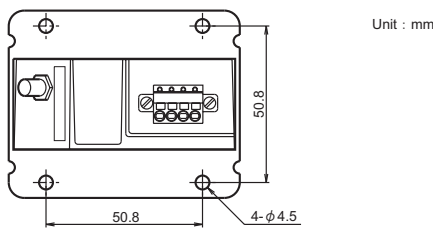

FK-202F -4(Screw Mount : Multi-pitch)

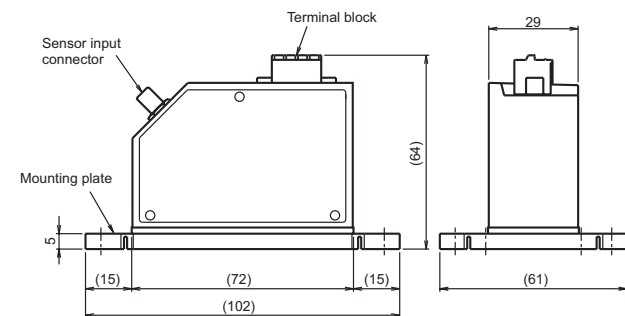
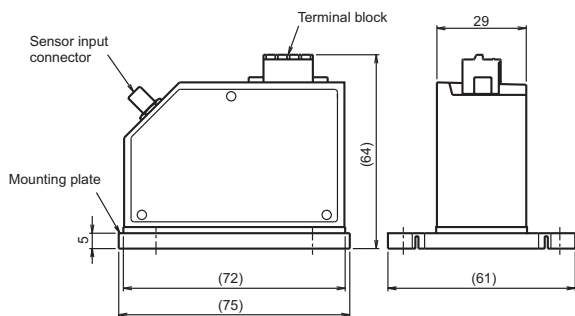
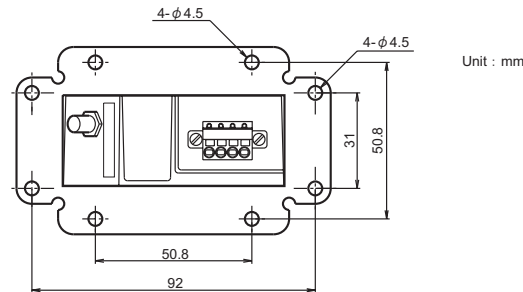

Note) Exchange the transducer as a loop of the sensor, the extension cable and the driver, when replacing the VK-202A, the RD-05A or the transducer made by the other manufacturers with the FK-202F transducer.

FW Extension Cable Model Code Number and Outline Drawing

Model Code Number

FW-202F□-□□

L	Armor		Cable length (L)	
	Without		40	4.0 m
A	With (Without fluoro resin coating)		45	4.5 m
			80	8.0 m
T	With (With fluoro resin coating)		85	8.5 m

FW-202FL(Without Armor)

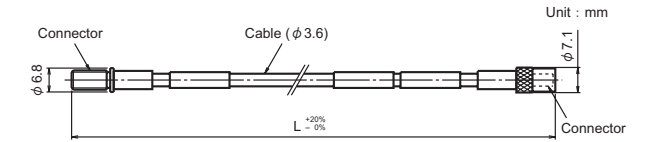

FW-202FA(With Armor[Without fluoro resin coating])

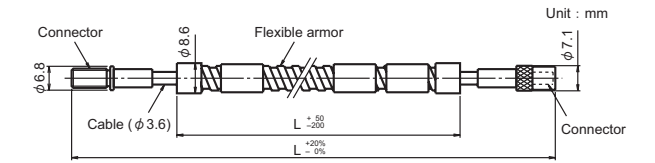

FW-202FT(With Armor[With fluoro resin coating])

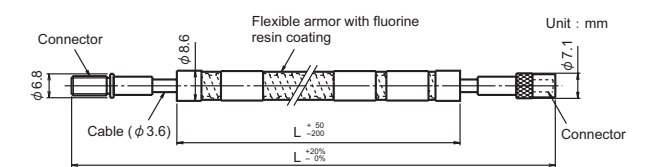

FL Sensor Model Code Number and Outline Drawing

Standard Type Sensor Model Code Number (Sensor Tip Diameter : 5 mm)

FL-202F05□-□□-□□-□□-□□

L	Armor		Thread size		Unthreaded length (L1)	Case length(L2)	Cable length (L3)	
	Without		M1	M8 × 1			10 mm STEP, 0-230 mm L1 L2 - 20 mm e.g.) 06=60 mm	10 mm STEP, 20-250 mm e.g.) 25=250 mm
A	With (Without fluoro resin coating)		U1	1/4-28UNF	0.1inch STEP, 0-9.2 inches L1 L2 - 0.7 inches e.g.) 04=0.4 inch	0.1 inch STEP, 0.8-9.9 inches e.g.) 35=3.5 inch	10	1.0 m
				50			5.0 m	
T	With (With fluoro resin coating)						90	9.0 m

When a metric screw is selected, specified in mm.
When a unify screw is selected, specified in inch.

FL-202F05L(Without Armor)

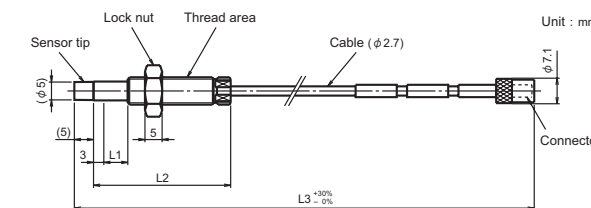

FL-202F05A(With Armor[Without fluoro resin coating])

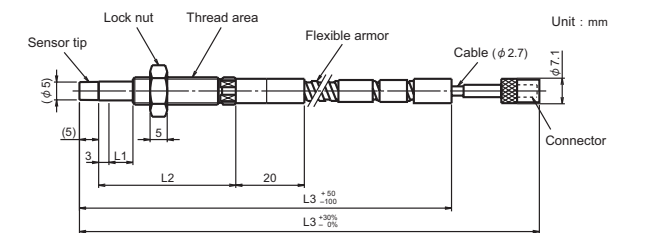

FL-202F05T(With Armor[With fluoro resin coating])

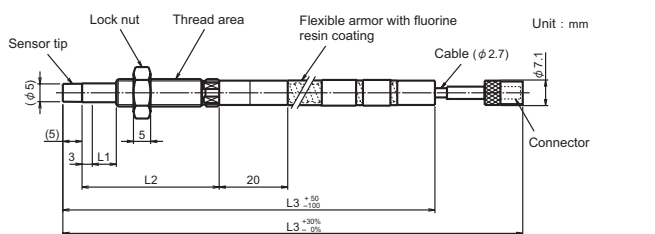

Standard Type Sensor Model Code Number (Sensor Tip Diameter : 8 mm)

FL-202F08 - - - -

Armor		Thread size		Unthreaded length (L1)	Case length (L2)	Cable length (L3)	
L	Without	M2	M10 × 1	10 mm STEP, 0-230 mm L1 L2 - 20 mm e.g.) 06=60 mm	10 mm STEP, 20-250 mm e.g.) 25=250 mm	05	0.5 m
A	With (Without fluoro resin coating)	U2	3/8-24UNF			10	1.0 m
T	With (With fluoro resin coating)			0.1 inch STEP, 0-9.2 inches L1 L2 - 0.7 inches e.g.) 04=0.4 inch	0.1 inch STEP, 0.8-9.9 inches e.g.) 35=3.5 inch	50	5.0 m
						90	9.0 m
When a metric screw is selected, specified in mm. When a unify screw is selected, specified in inch.							

FL-202F08L (Without Armor)

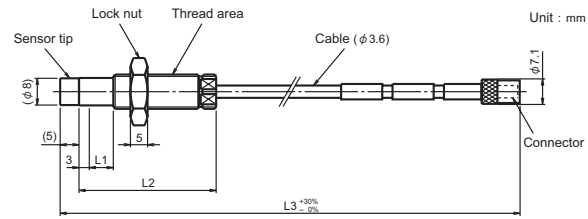

FL-202F08A (With Armor[Without fluoro resin coating])

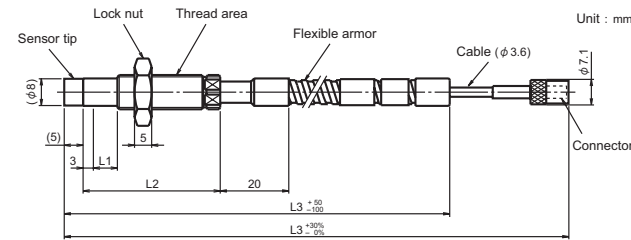

FL-202F08T (With Armor[With fluoro resin coating])

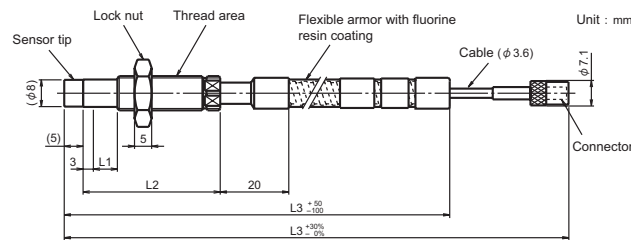

Reverse Mount Type Sensor Model Code Number (Sensor Tip Diameter : 8 mm)

FL-202F08R - - - -

Thread size		Unthreaded length (L1)	Case length(L2)	Cable length(L3)	
M2	M10 × 1	R5=5 mm	03=30 mm	05	0.5 m
U2	3/8-24UNF	02=0.2 inches	12=1.2 inches	10	1.0 m
				50	5.0 m
				90	9.0 m
When a metric screw is selected, specified in mm. When a unify screw is selected, specified in inch.					

FL-202F08R (Without Armor)

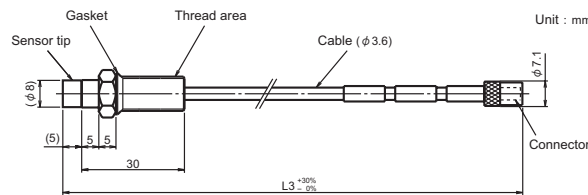

Typical System Configuration

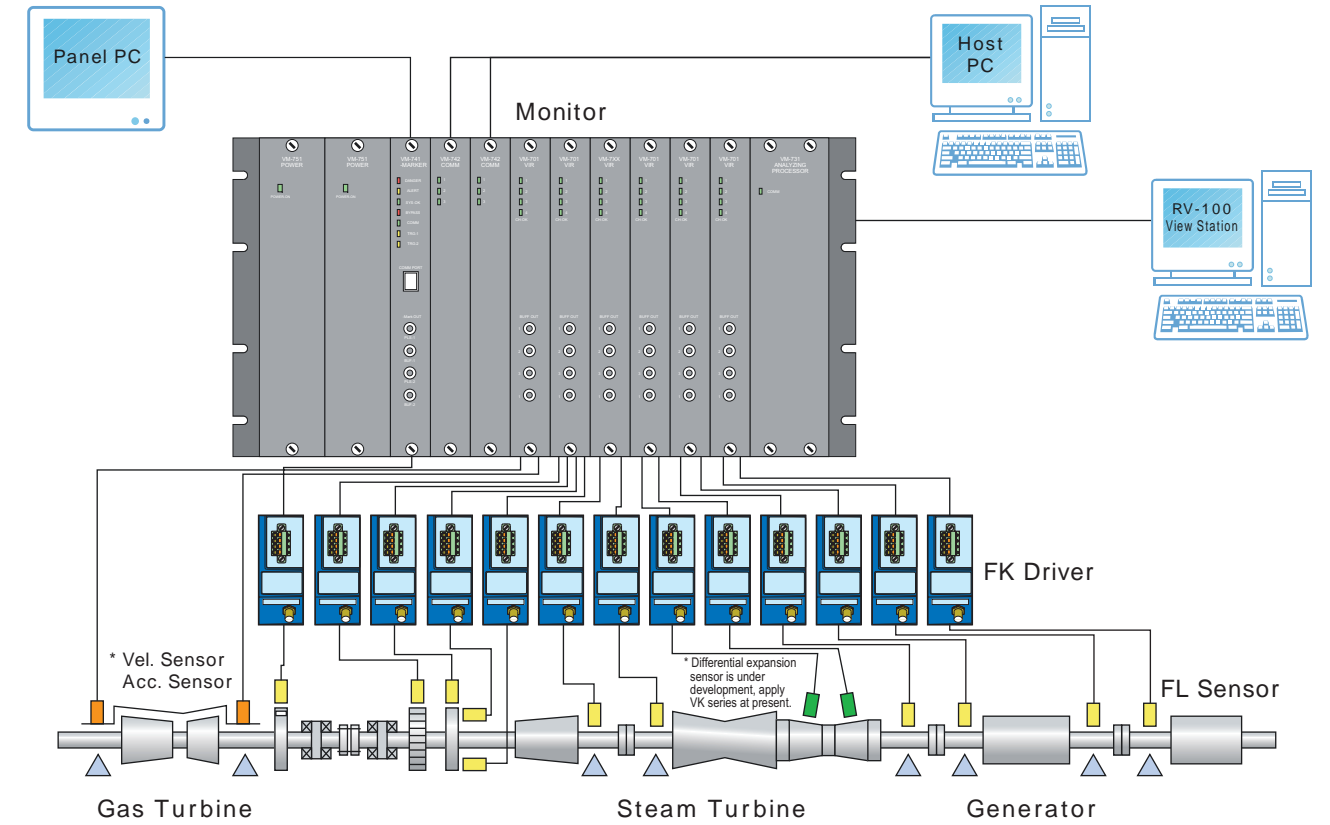

Specifications

Standard Calibration Target	JIS SCM440 flat surface
Measurement Range	0.25 to 2.25 mm from sensor tip
Scale Factor	7.87 V/mm
Scale Factor Tolerance*1	Within 7.87 V/mm ± 5% (When system cable length is 5 m.) Within 7.87 V/mm ± 6.5% (When system cable length is 9 m.)
Linear Characteristics*1	Within ± 25 μm for a straight line of 7.87 V/mm (When system cable length is 5 m.) Within ± 38 μm for a straight line of 7.87 V/mm (When system cable length is 9m.)
Frequency Response*1	DC to 10 kHz (- 3 dB)
Sensor Tip Diameter	Approx. 5 mm or Approx. 8 mm
System Cable Length	5 m or 9 m
Operational Temperature Range	FL sensor : - 35 to + 177 FW extension cable : - 35 to + 177 FK driver : - 35 to + 80 Relay connector : - 35 to + 125
Operational Humidity Range	30 to 95% RH (No condensation, submerge) (However, the sensor itself is 100%RH)
Power	Within - 24 VDC ± 10%
Terminal Block	Spring lock terminal

Specifications of *1 above apply under the following conditions :

- Standard calibration target SCM440 flat surface (15 mm or more, t=5 mm or more)
- - 24.0 VDC Power source voltage
- Load resistance 10 k
- Ambient temperature 25